

Bänder und Bukkalröhrchen
Bands and buccal tubes

Inhaltsverzeichnis – Bänder Index – Bands

Molarenbänder	3.3
Beschweißte Molarenbänder und Bukkalröhrchen (zum Aufschweißen).	3.6
Bukkalröhrchen zum Kleben	3.24
Nickelfreie Produkte	3.27
Aufschweißdienst	3.28
Prämolarenbänder	3.29
Lingualschlösser	3.30

Molar bands	3.3
Prewelded Molar bands and buccal tubes (for welding)	3.6
Buccal tubes for direct bonding	3.24
NiFree Products.	3.27
Prewelding service	3.28
Premolar bands	3.29
Lingual cleats	3.30

Bänder – Bands

perfekter anatomischer Sitz durch linguale und bukkale Adaption und Einschnitte
perfect anatomical fit through lingual and buccal adaption and cusp indents

leichtes Setzen durch approximal verringerte Bandstärke
easy placing through reduced interproximal band thickness

Snap-on Effekt
snap-on effect

Lasermarkierung
laser marking

statistisch berechnete Sortimente in bis zu 32 Größen
statistically calculated assortments in up to 32 sizes

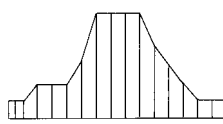



1. Molarenbänder – 1. Molar bands

W-Fit Form (1. Molar)



- klassische Form
- steifes Bandmaterial

- classical form
- stiffer band material

Easy-Fit® Form (1. Molar)



- ausgeprägte anatomische Kontur
- weiches Bandmaterial

- pronounced anatomical contour
- soft material

Dura-Fit® Form (1. Molar)



- ausgeprägte anatomische Kontur
- hartes Bandmaterial
- standardmäßig mit laser-aufgerauhter Bandinnenseite

- Pronounced anatomical contour
- stiffer band material
- molar band laser etched as standard

OK-Bänder Molaren Maxillary molar bands

Bei Bestellung von Einzelbändern bitte die Bestellnummer mit der gewünschten **Bandgröße** ergänzen.
When ordering single bands please add required **band size** to the given order numbers.

CE 0297

OK / Maxillary



Zahn tooth	Band-Typ band-type	Einzelbänder single bands		Bändergröße band size	Bänder Sätze je Hälfte links/rechts band kits half left/half right		
		rechts/right	links/left		100 St./pieces	200 St./pieces	400 St./pieces
 	Easy-Fit	1883-00..	1882-00..	05...36	1880-0100	1880-0200	1880-0400
 	Dura-Fit	2883-00..	2882-00..	05...36	2880-0100	2880-0200	2880-0400
 	W-Fit	883-00..	882-00..	01...32	880-0100	880-0200	880-0400
 	–	887-00..	886-00..	97...28	885-0100	885-0200	885-0400



Sofern nicht anders vermerkt, liefern wir mit lingualen Setzlaschen.
If not otherwise requested, we supply with lingual seating eyelets.

UK-Bänder Molaren Mandibular molar bands









Bei Bestellung von Einzelbändern bitte die Bestellnummer mit der gewünschten **Bandgröße** ergänzen.
When ordering single bands please add required **band size** to the given order numbers.

CE 0297



3

UK / Mandibular

Zahn tooth	Band-Typ band-type	Einzelbänder single bands		Bändergröße band size	Bänder Sätze je Hälfte links/rechts band kits half left/half right		
		rechts/right	links/left		100 St./pieces	200 St./pieces	400 St./pieces
 	Easy-Fit	1893-00..	1892-00..	05...36	1890-0100	1890-0200	1890-0400
 	Dura-Fit	2893-00..	2892-00..	05...36	2890-0100	2890-0200	2890-0400
 	W-Fit	893-00..	892-00..	01...32	890-0100	890-0200	890-0400
 	–	897-00..	896-00..	01...32	895-0100	895-0200	895-0400



Sofern nicht anders vermerkt, liefern wir mit lingualen Setzlaschen.
If not otherwise requested, we supply with lingual seating eyelets.

Flat-Line
Bukkälörhrchen
Buccal tubes

CE 0297

Roth-System



OK/ Maxillary	Zahn tooth	Torque	Angulation	distaler Offset distal offset	zum Aufschiessen / for welding		auf Pad / on pad		
					rechts/right	links/left	rechts/right	links/left	
 convertible		-14°	0°	14°	.018" x .025"	741-0703	740-0703	741-0704	740-0704
					.022" x .028"	741-0701	740-0701	741-0702	740-0702
 convertible		-14°	0°	14°	.018" x .025"	741-0727	740-0727	741-0728	740-0728
					.022" x .028"	741-0725	740-0725	741-0726	740-0726
 convertible		-14°	0°	14°	.018" x .025"	741-0713	740-0713	-	-
					.022" x .028"	741-0711	740-0711	-	-
 convertible		-14°	0°	14°	.018" x .025"	741-0723	740-0723	-	-
					.022" x .028"	741-0721	740-0721	-	-
		-14°	0°	14°	.018" x .025"	741-0803	740-0803	741-0804	740-0804
					.022" x .028"	741-0801	740-0801	741-0802	740-0802

Molarenbänder mit aufgeschweißten Bukkalröhrchen

Molar bands with prewelded buccal tubes

CE 0297

Bei Bestellung von Einzelbändern bitte die Bestellnummer mit der gewünschten **Bandgröße** ergänzen.
When ordering single bands please add required **band size** to the given order numbers.



3

Roth-System



	Band-Typ band-type	Einzelbänder single bands		5 St. pro Größe 5 pcs. of each size	Bändergröße band size	Bänder Sätze je Hälfte links/rechts band kits half left/half right		
		rechts/right	links/left			100 St./pieces	200 St./pieces	400 St./pieces
.018" x .025"	W-Fit	883-72..	882-71..	01-32	880-0171	880-0271	880-0471	
	Easy-Fit	1883-72..	1882-71..		05-36	1880-0171	1880-0271	1880-0471
	Dura-Fit	2883-72..	2882-71..		05-36	2880-0171	2880-0271	2880-0471
.022" x .028"	W-Fit	883-88..	882-87..	01-32	880-0187	880-0287	880-0487	
	Easy-Fit	1883-88..	1882-87..		05-36	1880-0187	1880-0287	1880-0487
	Dura-Fit	2883-88..	2882-87..		05-36	2880-0187	2880-0287	2880-0487
.018" x .025"	W-Fit	883-21..	882-21..	01-32	880-0121	880-0221	880-0421	
	Easy-Fit	1883-21..	1882-21..		05-36	1880-0121	1880-0221	1880-0421
	Dura-Fit	2883-21..	2882-21..		05-36	2880-0121	2880-0221	2880-0421
.022" x .028"	W-Fit	883-22..	882-22..	01-32	880-0122	880-0222	880-0422	
	Easy-Fit	1883-22..	1882-22..		05-36	1880-0122	1880-0222	1880-0422
	Dura-Fit	2883-22..	2882-22..		05-36	2880-0122	2880-0222	2880-0422
.018" x .025"	W-Fit	883-10..	882-10..	01-32	880-0110	880-0210	880-0410	
	Easy-Fit	1883-10..	1882-10..		05-36	1880-0110	1880-0210	1880-0410
	Dura-Fit	2883-10..	2882-10..		05-36	2880-0110	2880-0210	2880-0410
.022" x .028"	W-Fit	883-11..	882-11..	01-32	880-0111	880-0211	880-0411	
	Easy-Fit	1883-11..	1882-11..		05-36	1880-0111	1880-0211	1880-0411
	Dura-Fit	2883-11..	2882-11..		05-36	2880-0111	2880-0211	2880-0411
.018" x .025"	W-Fit	883-19..	882-19..	01-32	880-0119	880-0219	880-0419	
	Easy-Fit	1883-19..	1882-19..		05-36	1880-0119	1880-0219	1880-0419
	Dura-Fit	2883-19..	2882-19..		05-36	2880-0119	2880-0219	2880-0419
.022" x .028"	W-Fit	883-20..	882-20..	01-32	880-0120	880-0220	880-0420	
	Easy-Fit	1883-20..	1882-20..		05-36	1880-0120	1880-0220	1880-0420
	Dura-Fit	2883-20..	2882-20..		05-36	2880-0120	2880-0220	2880-0420
.018" x .025"	-	887-74..	886-73..	97-28	885-0173	885-0273	885-0473	
.022" x .028"	-	887-90..	886-89..	97-28	885-0189	885-0289	885-0489	



Sofern nicht anders vermerkt, liefern wir mit lingualem Setzlaschen.
If not otherwise requested, we supply with lingual seating eyelets.

Flat-Line
Bukkälrröhrchen
Buccal tubes

CE 0297

Roth-System

UK / Mandibular	Zahn tooth	Torque	Angulation	distaler Offset distal offset		zum Aufschiweißen / for welding		auf Pad / on pad		
						rechts/right	links/left	rechts/right	links/left	
 convertible		-30°	0°	4°		.018" x .025"	741-1703	740-1703	741-1704	740-1704
						.022" x .028"	741-1701	740-1701	741-1702	740-1702
for Lip Bumper Ø .045 inch Ø 1,15 mm  convertible		-30°	0°	4°		.018" x .025"	741-1707	740-1707	-	-
						.022" x .028"	741-1705	740-1705	-	-
for Lip Bumper Ø .045 inch Ø 1,15 mm  convertible		-30°	0°	4°		.018" x .025"	741-1723	740-1723	-	-
						.022" x .028"	741-1721	740-1721	-	-
 convertible		-30°	0°	4°		.018" x .025"	741-1803	740-1803	741-1804	740-1804
						.022" x .028"	741-1801	740-1801	741-1802	740-1802

Molarenbänder mit aufgeschweißten Bukkalröhrchen

Molar bands with prewelded buccal tubes

CE 0297

Bei Bestellung von Einzelbändern bitte die Bestellnummer mit der gewünschten **Bandgröße** ergänzen.
When ordering single bands please add required **band size** to the given order numbers.



3

Roth-System







	Band-Typ band-type	Einzelbänder single bands		Bändergröße band size	Bänder Sätze je Hälfte links/rechts band kits half left/half right		
		rechts/right	links/left		100 St./pieces	200 St./pieces	400 St./pieces
.018" x .025"	W-Fit	893-47..	892-46..	01-32	890-0146	890-0246	890-0446
	Easy-Fit	1893-47..	1892-46..	05-36	1890-0146	1890-0246	1890-0446
	Dura-Fit	2893-47..	2892-46..	05-36	2890-0146	2890-0246	2890-0446
.022" x .028"	W-Fit	893-25..	892-24..	01-32	890-0124	890-0224	890-0424
	Easy-Fit	1893-25..	1892-24..	05-36	1890-0124	1890-0224	1890-0424
	Dura-Fit	2893-25..	2892-24..	05-36	2890-0124	2890-0224	2890-0424
.018" x .025"	W-Fit	893-03..	892-03..	01-32	890-0103	890-0203	890-0403
	Easy-Fit	1893-03..	1892-03..	05-36	1890-0103	1890-0203	1890-0403
	Dura-Fit	2893-03..	2892-03..	05-36	2890-0103	2890-0203	2890-0403
.022" x .028"	W-Fit	893-04..	892-04..	01-32	890-0104	890-0204	890-0404
	Easy-Fit	1893-04..	1892-04..	05-36	1890-0104	1890-0204	1890-0404
	Dura-Fit	2893-04..	2892-04..	05-36	2890-0104	2890-0204	2890-0404
.018" x .025"	W-Fit	893-13..	892-13..	01-32	890-0113	890-0213	890-0413
	Easy-Fit	1893-13..	1892-13..	05-36	1890-0113	1890-0213	1890-0413
	Dura-Fit	2893-13..	2892-13..	05-36	2890-0113	2890-0213	2890-0413
.022" x .028"	W-Fit	893-48..	892-47..	01-32	890-0147	890-0247	890-0447
	Easy-Fit	1893-48..	1892-47..	05-36	1890-0147	1890-0247	1890-0447
	Dura-Fit	2893-48..	2892-47..	05-36	2890-0147	2890-0247	2890-0447
.018" x .025"	-	897-49..	896-48..	01-32	895-0148	895-0248	895-0448
.022" x .028"	-	897-27..	896-26..	01-32	895-0126	895-0226	895-0426







Sofern nicht anders vermerkt, liefern wir mit lingualen Setzlaschen.
If not otherwise requested, we supply with lingual seating eyelets.

Mc Laughlin / Bennett / Trevisi-System

OK / Maxillary	Zahn tooth	Torque	Angulation	distaler Offset distal offset		zum Aufschweißen / for welding		auf Pad / on pad	
						rechts/right	links/left	rechts/right	links/left
 convertible		-14°	0°	10°	.018" x .025"	728-0713	727-0713	-	-
					.022" x .028"	728-0711	727-0711	-	-
		-14°	0°	10°	.018" x .025"	728-0803	727-0803	728-0804	727-0804
					.022" x .028"	728-0801	727-0801	728-0802	727-0802

UK / Mandibular

UK / Mandibular						zum Aufschweißen / for welding		auf Pad / on pad	
						rechts/right	links/left	rechts/right	links/left
 convertible		-20°	0°	0°	.018" x .025"	728-1703	727-1703	-	-
					.022" x .028"	728-1701	727-1701	-	-
		-10°	0°	0°	.018" x .025"	728-1803	727-1803	728-1804	727-1804
					.022" x .028"	728-1801	727-1801	728-1802	727-1802

Molarenbänder mit aufgeschweißten Bukkalröhrchen Molar bands with prewelded buccal tubes

CE 0297

Bei Bestellung von Einzelbändern bitte die Bestellnummer mit der gewünschten **Bandgröße** ergänzen.
When ordering single bands please add required **band size** to the given order numbers.



3

Mc Laughlin / Bennett / Trevisi-System

	Band-Typ band-type	Einzelbänder single bands		5 St. pro Größe 5 pcs. of each size	Bändergröße band size	Bänder Sätze je Hälfte links/rechts band kits half left/half right		
		rechts/right	links/left			100 St./pieces	200 St./pieces	400 St./pieces
.018" x .025"	W-Fit	883-34..	882-34..	5 St. pro Größe 5 pcs. of each size	01-32	880-0134	880-0234	880-0434
	Easy-Fit	1883-34..	1882-34..			1880-0134	1880-0234	1880-0434
	Dura-Fit	2883-34..	2882-34..			2880-0134	2880-0234	2880-0434
.022" x .028"	W-Fit	883-13..	882-13..	5 St. pro Größe 5 pcs. of each size	01-32	880-0113	880-0213	880-0413
	Easy-Fit	1883-13..	1882-13..			1880-0113	1880-0213	1880-0413
	Dura-Fit	2883-13..	2882-13..			2880-0113	2880-0213	2880-0413
.018" x .025"	-	887-32..	886-32..		97-28	885-0132	885-0232	885-0432
.022" x .028"	-	887-12..	886-12..		97-28	885-0112	885-0212	885-0412



.018" x .025"	W-Fit	893-38..	892-38..	5 St. pro Größe 5 pcs. of each size	01-32	890-0138	890-0238	890-0438
	Easy-Fit	1893-38..	1892-38..			1890-0138	1890-0238	1890-0438
	Dura-Fit	2893-38..	2892-38..			2890-0138	2890-0238	2890-0438
.022" x .028"	W-Fit	893-16..	892-16..	5 St. pro Größe 5 pcs. of each size	01-32	890-0116	890-0216	890-0416
	Easy-Fit	1893-16..	1892-16..			1890-0116	1890-0216	1890-0416
	Dura-Fit	2893-16..	2892-16..			2890-0116	2890-0216	2890-0416
.018" x .025"	-	897-32..	896-32..		01-32	895-0132	895-0232	895-0432
.022" x .028"	-	897-17..	896-17..		01-32	895-0117	895-0217	895-0417





Sofern nicht anders vermerkt, liefern wir mit lingualen Setzlaschen.
If not otherwise requested, we supply with lingual seating eyelets.



Flat-Line
Bukkälörhrchen
Buccal tubes

CE 0297

Hilgers-System

	Zahn tooth	Torque	Angulation	distaler Offset distal offset		zum Aufschweißen / for welding		auf Pad / on pad	
						rechts/right	links/left	rechts/right	links/left
OK / Maxillary									
occlusal headgear tube									
	$\frac{6}{ } \frac{6}{ }$	-10°	0°	15°	.018" x .025"	774-0703	773-0703	-	-
convertible					.022" x .028"	774-0701	773-0701	-	-
	$\frac{7}{ } \frac{7}{ }$	-10°	0°	12°	.018" x .025"	774-0803	773-0803	774-0804	773-0804
					.022" x .028"	774-0801	773-0801	774-0802	773-0802

UK /
Mandibular

	Zahn tooth	Torque	Angulation	distaler Offset distal offset		zum Aufschweißen / for welding		auf Pad / on pad	
						rechts/right	links/left	rechts/right	links/left
	$\frac{6}{ } \frac{6}{ }$	-27°	5°	12°	.018" x .025"	774-1703	773-1703	-	-
convertible					.022" x .028"	774-1701	773-1701	-	-
	$\frac{7}{ } \frac{7}{ }$	-27°	0°	12°	.018" x .025"	774-1803	773-1803	774-1804	773-1804
					.022" x .028"	774-1801	773-1801	774-1802	773-1802

Molarenbänder mit aufgeschweißten Bukkalröhrchen

Molar bands with prewelded buccal tubes

CE 0297

Bei Bestellung von Einzelbändern bitte die Bestellnummer mit der gewünschten **Bandgröße** ergänzen.
When ordering single bands please add required **band size** to the given order numbers.



3

Hilgers-System



	Band-Typ band-type	Einzelbänder single bands		Bändergröße band size	Bänder Sätze je Hälfte links/rechts band kits half left/half right		
		rechts/right	links/left		100 St./pieces	200 St./pieces	400 St./pieces
.018" x .025"	W-Fit	883-26..	882-26..	01-32	880-0126	880-0226	880-0426
	Easy-Fit	1883-26..	1882-26..	05-36	1880-0126	1880-0226	1880-0426
	Dura-Fit	2883-26..	2882-26..	05-36	2880-0126	2880-0226	2880-0426
.022" x .028"	W-Fit	883-05..	882-05..	01-32	880-0105	880-0205	880-0405
	Easy-Fit	1883-05..	1882-05..	05-36	1880-0105	1880-0205	1880-0405
	Dura-Fit	2883-05..	2882-05..	05-36	2880-0105	2880-0205	2880-0405
.018" x .025"	-	887-27..	886-27..	97-28	885-0127	885-0227	885-0427
.022" x .028"	-	887-06..	886-06..	97-28	885-0106	885-0206	885-0406







.018" x .025"	W-Fit	893-07..	892-07..	01-32	890-0107	890-0207	890-0407
	Easy-Fit	1893-07..	1892-07..	05-36	1890-0107	1890-0207	1890-0407
	Dura-Fit	2893-07..	2892-07..	05-36	2890-0107	2890-0207	2890-0407
.022" x .028"	W-Fit	893-34..	892-34..	01-32	890-0134	890-0234	890-0434
	Easy-Fit	1893-34..	1892-34..	05-36	1890-0134	1890-0234	1890-0434
	Dura-Fit	2893-34..	2892-34..	05-36	2890-0134	2890-0234	2890-0434
.018" x .025"	-	897-08..	896-08..	01-32	895-0108	895-0208	895-0408
.022" x .028"	-	897-35..	896-35..	01-32	895-0135	895-0235	895-0435







Sofern nicht anders vermerkt, liefern wir mit lingualen Setzlaschen.
If not otherwise requested, we supply with lingual seating eyelets.

Alexander-System

	Zahn tooth	Torque	Angulation	distaler Offset distal offset					
						zum Aufschweißen / for welding	auf Pad / on pad	rechts/right	links/left
OK / Maxillary									
occlusal headgear tube									
 convertible	$\frac{6}{6}$	-10°	0°	15°	.018" x .025"	776-0703	775-0703	-	-
	$\frac{7}{7}$	-10°	0°	6°	.018" x .025"	776-0803	775-0803	776-0804	775-0804

**UK /
Mandibular**

									
 convertible	$\frac{6}{6}$	-22°	6°	5°	.018" x .025"	776-1703	775-1703	776-1704	775-1704
	$\frac{7}{7}$	-27°	0°	6°	.018" x .025"	776-1803	775-1803	776-1804	775-1804

Molarenbänder mit aufgeschweißten Bukkalröhrchen

Molar bands with prewelded buccal tubes

CE 0297

Bei Bestellung von Einzelbändern bitte die Bestellnummer mit der gewünschten **Bandgröße** ergänzen.
When ordering single bands please add required **band size** to the given order numbers.



3

Alexander-System



	Band-Typ band-type	Einzelbänder single bands		Bändergröße band size	Bänder Sätze je Hälfte links/rechts band kits half left/half right		
		rechts/right	links/left		100 St./pieces	200 St./pieces	400 St./pieces
.018" x .025"	W-Fit	883-28..	882-28..	01-32	880-0128	880-0228	880-0428
	Easy-Fit	1883-28..	1882-28..	05-36	1880-0128	1880-0228	1880-0428
	Dura-Fit	2883-28..	2882-28..	05-36	2880-0128	2880-0228	2880-0428
.018" x .025"	-	887-29..	886-29..	97-28	885-0129	885-0229	885-0429



.018" x .025"	W-Fit	893-12..	892-12..	01-32	890-0112	890-0212	890-0412
	Easy-Fit	1893-12..	1892-12..	05-36	1890-0112	1890-0212	1890-0412
	Dura-Fit	2893-12..	2892-12..	05-36	2890-0112	2890-0212	2890-0412
.018" x .025"	-	897-15..	896-15..	01-32	895-0115	895-0215	895-0415

















Sofern nicht anders vermerkt, liefern wir mit lingualen Setzlaschen.
If not otherwise requested, we supply with lingual seating eyelets.

Flat-Line
Bukkälörhrchen
Buccal tubes

CE 0297

Standard-Edgewise-System / Standard-Ricketts-System

OK / Maxillary	Zahn tooth	Torque	Angulation	distaler Offset distal offset		 zum Aufschweißen / for welding		 auf Pad / on pad		
						rechts/right	links/left	rechts/right	links/left	
		0°	0°	0°	.018" x .025"	749-0310	749-0210	-	-	
					.022" x .028"	749-0320	749-0220	-	-	
gingival headgear tube			0°	0°	0°	.018" x .025"	752-0310	752-0210	-	-
 convertible		0°	0°	0°	.018" x .025"	743-2703	742-2703	743-2704	742-2704	
					.022" x .028"	743-2701	742-2701	743-2702	742-2702	
UK / Mandibular			0°	0°	0°	.018" x .025"	748-0311	748-0211	748-8311	748-8211
						.022" x .028"	748-0321	748-0221	748-8321	748-8221
		0°	0°	0°	.018" x .025"	750-0410	750-0410	750-8410	750-8410	
 convertible		0°	0°	0°	.018" x .025"	742-2703	743-2703	742-2704	743-2704	
					.022" x .028"	742-2701	743-2701	742-2702	743-2702	

Molarenbänder mit aufgeschweißten Bukkalröhrchen

Molar bands with prewelded buccal tubes

CE 0297

Bei Bestellung von Einzelbändern bitte die Bestellnummer mit der gewünschten **Bandgröße** ergänzen.
When ordering single bands please add required **band size** to the given order numbers.







	Band-Typ band-type	Einzelbänder single bands		5 St. pro Größe 5 pcs. of each size	Bändergröße band size	Bänder Sätze je Hälfte links/rechts band kits half left/half right		
		rechts/right	links/left			100 St./pieces	200 St./pieces	400 St./pieces
.018" x .025"	W-Fit	883-16..	882-15..	01-32	880-0115	880-0215	880-0415	
	Easy-Fit	1883-16..	1882-15..	05-36	1880-0115	1880-0215	1880-0415	
	Dura-Fit	2883-16..	2882-15..	05-36	2880-0115	2880-0215	2880-0415	
.022" x .028"	W-Fit	883-36..	882-35..	01-32	880-0135	880-0235	880-0435	
	Easy-Fit	1883-36..	1882-35..	05-36	1880-0135	1880-0235	1880-0435	
	Dura-Fit	2883-36..	2882-35..	05-36	2880-0135	2880-0235	2880-0435	
.018" x .025"	W-Fit	883-54..	882-53..	01-32	880-0153	880-0253	880-0453	
	Easy-Fit	1883-54..	1882-53..	05-36	1880-0153	1880-0253	1880-0453	
	Dura-Fit	2883-54..	2882-53..	05-36	2880-0153	2880-0253	2880-0453	
.018" x .025"	W-Fit	883-66..	882-65..	01-32	880-0165	880-0265	880-0465	
	Easy-Fit	1883-66..	1882-65..	05-36	1880-0165	1880-0265	1880-0465	
	Dura-Fit	2883-66..	2882-65..	05-36	2880-0165	2880-0265	2880-0465	
.022" x .028"	W-Fit	883-67..	882-66..	01-32	880-0166	880-0266	880-0466	
	Easy-Fit	1883-67..	1882-66..	05-36	1880-0166	1880-0266	1880-0466	
	Dura-Fit	2883-67..	2882-66..	05-36	2880-0166	2880-0266	2880-0466	

.018" x .025"	W-Fit	893-02..	892-02..	01-32	890-0102	890-0202	890-0402
	Easy-Fit	1893-02..	1892-02..	05-36	1890-0102	1890-0202	1890-0402
	Dura-Fit	2893-02..	2892-02..	05-36	2890-0102	2890-0202	2890-0402
.022" x .028"	W-Fit	893-06..	892-06..	01-32	890-0106	890-0206	890-0406
	Easy-Fit	1893-06..	1892-06..	05-36	1890-0106	1890-0206	1890-0406
	Dura-Fit	2893-06..	2892-06..	05-36	2890-0106	2890-0206	2890-0406
.018" x .025"	W-Fit	893-10..	892-10..	01-32	890-0110	890-0210	890-0410
	Easy-Fit	1893-10..	1892-10..	05-36	1890-0110	1890-0210	1890-0410
	Dura-Fit	2893-10..	2892-10..	05-36	2890-0110	2890-0210	2890-0410
.018" x .025"	W-Fit	893-68..	892-67..	01-32	890-0167	890-0267	890-0467
	Easy-Fit	1893-68..	1892-67..	05-36	1890-0167	1890-0267	1890-0467
	Dura-Fit	2893-68..	2892-67..	05-36	2890-0167	2890-0267	2890-0467
.022" x .028"	W-Fit	893-69..	892-68..	01-32	890-0168	890-0268	890-0468
	Easy-Fit	1893-69..	1892-68..	05-36	1890-0168	1890-0268	1890-0468
	Dura-Fit	2893-69..	2892-68..	05-36	2890-0168	2890-0268	2890-0468



Sofern nicht anders vermerkt, liefern wir mit lingualen Setzlaschen.
If not otherwise requested, we supply with lingual seating eyelets.

Ricketts - 4. Dimension-System

OK / Maxillary	Zahn tooth	Torque	Angulation	distaler Offset distal offset		zum Aufschweißen / for welding		auf Pad / on pad	
						rechts/right	links/left	rechts/right	links/left
gingival headgear tube  convertible	$\frac{6}{ } \frac{6}{ }$	-10°	0°	7°	.018" x .025"	755-1316	755-1216	-	-
occlusal headgear tube  convertible	$\frac{6}{ } \frac{6}{ }$	-10°	0°	7°	.018" x .025"	759-1316	759-1216	-	-
	$\frac{7}{ } \frac{6}{ } \frac{6}{ } \frac{7}{ }$	-10°	0°	7°	.018" x .025"	757-0312	757-0212	757-8312	757-8212

UK / Mandibular		$\frac{6}{ } \frac{6}{ }$	-22°	5°	12°	.018" x .025"				
							rechts/right	links/left	rechts/right	links/left
convertible						756-1314	756-1214	-	-	
		$\frac{7}{ } \frac{7}{ }$	-22°	0°	12°	.018" x .025"	758-0314	758-0214	758-8314	758-8214

Molarenbänder mit aufgeschweißten Bukkalröhrchen

Molar bands with prewelded buccal tubes

CE 0297

Bei Bestellung von Einzelbändern bitte die Bestellnummer mit der gewünschten **Bandgröße** ergänzen.
When ordering single bands please add required **band size** to the given order numbers.



3

Ricketts - 4. Dimension-System



	Band-Typ band-type	Einzelbänder single bands		Bändergröße band size	Bänder Sätze je Hälfte links/rechts band kits half left/half right		
		rechts/right	links/left		100 St./pieces	200 St./pieces	400 St./pieces
	W-Fit	883-59..	882-59..	01-32	880-0159	880-0259	880-0459
.018" x .025"	Easy-Fit	1883-59..	1882-59..	05-36	1880-0159	1880-0259	1880-0459
	Dura-Fit	2883-59..	2882-59..	05-36	2880-0159	2880-0259	2880-0459
	W-Fit	883-41..	882-41..	01-32	880-0141	880-0241	880-0441
.018" x .025"	Easy-Fit	1883-41..	1882-41..	05-36	1880-0141	1880-0241	1880-0441
	Dura-Fit	2883-41..	2882-41..	05-36	2880-0141	2880-0241	2880-0441
.018" x .025"	W-Fit	887-60..	886-60..	97-28	885-0160	885-0260	885-0460











	W-Fit	893-11..	892-11..	01-32	890-0111	890-0211	890-0411
.018" x .025"	Easy-Fit	1893-11..	1892-11..	05-36	1890-0111	1890-0211	1890-0411
	Dura-Fit	2893-11..	2892-11..	05-36	2890-0111	2890-0211	2890-0411
.018" x .025"	-	897-13..	896-13..	01-32	895-0113	895-0213	895-0413



Sofern nicht anders vermerkt, liefern wir mit lingualen Setzlaschen.
If not otherwise requested, we supply with lingual seating eyelets.

Andrews-System

OK / Maxillary	Zahn tooth	Torque	Angulation	distaler Offset distal offset		zum Aufschweißen / for welding		auf Pad / on pad	
						rechts/right	links/left	rechts/right	links/left
gingival headgear tube									
 convertible	$\frac{6}{ } \frac{6}{ }$	-9°	5°	10°	.022" x .028"	752-1322	752-1222	-	-
occlusal headgear tube									
 convertible	$\frac{6}{ } \frac{6}{ }$	-9°	5°	10°	.022" x .028"	762-1322	762-1222	-	-
	$\frac{7}{ } \frac{7}{ }$	-9°	0°	10°	.022" x .028"	748-0322	748-0222	748-8322	748-8222

UK / Mandibular									
 convertible	$\frac{6}{ } \frac{6}{ }$	-25°	2°	0	.022" x .028"	750-1324	750-1224	-	-
	$\frac{7}{ } \frac{7}{ }$	-30°	0°	0	.022" x .028"	748-0325	748-0225	748-8325	748-8225

Molarenbänder mit aufgeschweißten Bukkalröhrchen

Molar bands with prewelded buccal tubes

CE 0297

Bei Bestellung von Einzelbändern bitte die Bestellnummer mit der gewünschten **Bandgröße** ergänzen.
When ordering single bands please add required **band size** to the given order numbers.



Andrews-System



	Band-Typ band-type	Einzelbänder single bands		Bändergröße band size	Bänder Sätze je Hälfte links/rechts band kits half left/half right		
		rechts/right	links/left		100 St./pieces	200 St./pieces	400 St./pieces
	W-Fit	883-92..	882-91..	01-32	880-0191	880-0291	880-0491
.022" x .028"	Easy-Fit	1883-92..	1882-91..	05-36	1880-0191	1880-0291	1880-0491
	Dura-Fit	2883-92..	2882-91..	05-36	2880-0191	2880-0291	2880-0491
	W-Fit	883-43..	882-43..	01-32	880-0143	880-0243	880-0443
.022" x .028"	Easy-Fit	1883-43..	1882-43..	05-36	1880-0143	1880-0243	1880-0443
	Dura-Fit	2883-43..	2882-43..	05-36	2880-0143	2880-0243	2880-0443
.022" x .028"	-	887-94..	886-93..	97-28	885-0193	885-0293	885-0493



	W-Fit	893-29..	892-28..	01-32	890-0128	890-0228	890-0428
.022" x .028"	Easy-Fit	1893-29..	1892-28..	05-36	1890-0128	1890-0228	1890-0428
	Dura-Fit	2893-29..	2892-28..	05-36	2890-0128	2890-0228	2890-0428
.022" x .028"	-	897-31..	896-30..	01-32	895-0130	895-0230	895-0430



Sofern nicht anders vermerkt, liefern wir mit lingualen Setzlaschen.
If not otherwise requested, we supply with lingual seating eyelets.

Flat-Line
Bukkälörchen Sonderausführung
Buccal tubes - special execution

CE 0297

	Zahn tooth	Torque	Angulation	distaler Offset distal offset					
						zum Aufschweißen / for welding		auf Pad / on pad	
						rechts/right	links/left	rechts/right	links/left
OK / Maxillary		-10°	0°	8°	.018" x .025"	743-0703	742-0703	743-0704	742-0704
					.022" x .028"	743-0701	742-0701	743-0702	742-0702
convertible									
		0°	0°	0°	.018" x .025"	743-2703	742-2703	743-2704	742-2704
					.022" x .028"	743-2701	742-2701	743-2702	742-2702
convertible									
occlusal headgear tube									
		0°	0°	7°	.018" x .025"	759-1310	759-1210	-	-
					.022" x .028"	759-1320	759-1220	-	-
convertible									
UK / Mandibular		-25°	0°	6°	.018" x .025"	743-1703	742-1703	743-1704	742-1704
					.022" x .028"	743-1701	742-1701	743-1702	742-1702
convertible									
		0°	0°	0°	.018" x .025"	742-2703	743-2703	742-2704	743-2704
					.022" x .028"	742-2701	743-2701	742-2702	743-2702
convertible									
		0°	0°	7°	.018" x .025"	756-1310	756-1210	-	-
					.022" x .028"	756-1320	756-1220	-	-
convertible									



Molarenbänder mit aufgeschweißten Bukkalröhrchen Molar bands with prewelded buccal tubes

CE 0297

Bei Bestellung von Einzelbändern bitte die Bestellnummer mit der gewünschten **Bandgröße** ergänzen.
When ordering single bands please add required **band size** to the given order numbers.



3



	Band-Typ band-type	 Einzelbänder single bands		Bändergröße band size	 Bänder Sätze je Hälfte links/rechts band kits half left/half right		
		rechts/right	links/left		100 St./pieces	200 St./pieces	400 St./pieces
.018" x .025"	W-Fit	883-62..	882-61..	01-32	880-0161	880-0261	880-0461
	Easy-Fit	1883-62..	1882-61..	05-36	1880-0161	1880-0261	1880-0461
	Dura-Fit	2883-62..	2882-61..	05-36	2880-0161	2880-0261	2880-0461
.022" x .028"	W-Fit	883-63..	882-62..	01-32	880-0162	880-0262	880-0462
	Easy-Fit	1883-63..	1882-62..	05-36	1880-0162	1880-0262	1880-0462
	Dura-Fit	2883-63..	2882-62..	05-36	2880-0162	2880-0262	2880-0462
.018" x .025"	W-Fit	883-66..	882-65..	01-32	880-0165	880-0265	880-0465
	Easy-Fit	1883-66..	1882-65..	05-36	1880-0165	1880-0265	1880-0465
	Dura-Fit	2883-66..	2882-65..	05-36	2880-0165	2880-0265	2880-0465
.022" x .028"	W-Fit	883-67..	882-66..	01-32	880-0166	880-0266	880-0466
	Easy-Fit	1883-67..	1882-66..	05-36	1880-0166	1880-0266	1880-0466
	Dura-Fit	2883-67..	2882-66..	05-36	2880-0166	2880-0266	2880-0466
.018" x .025"	W-Fit	883-64..	882-63..	01-32	880-0163	880-0263	880-0463
	Easy-Fit	1883-64..	1882-63..	05-36	1880-0163	1880-0263	1880-0463
	Dura-Fit	2883-64..	2882-63..	05-36	2880-0163	2880-0263	2880-0463
.022" x .028"	W-Fit	883-65..	882-64..	01-32	880-0164	880-0264	880-0464
	Easy-Fit	1883-65..	1882-64..	05-36	1880-0164	1880-0264	1880-0464
	Dura-Fit	2883-65..	2882-64..	05-36	2880-0164	2880-0264	2880-0464
.018" x .025"	W-Fit	893-64..	892-63..	01-32	890-0163	890-0263	890-0463
	Easy-Fit	1893-64..	1892-63..	05-36	1890-0163	1890-0263	1890-0463
	Dura-Fit	2893-64..	2892-63..	05-36	2890-0163	2890-0263	2890-0463
.022" x .028"	W-Fit	893-65..	892-64..	01-32	890-0164	890-0264	890-0464
	Easy-Fit	1893-65..	1892-64..	05-36	1890-0164	1890-0264	1890-0464
	Dura-Fit	2893-65..	2892-64..	05-36	2890-0164	2890-0264	2890-0464
.018" x .025"	W-Fit	893-68..	892-67..	01-32	890-0167	890-0267	890-0467
	Easy-Fit	1893-68..	1892-67..	05-36	1890-0167	1890-0267	1890-0467
	Dura-Fit	2893-68..	2892-67..	05-36	2890-0167	2890-0267	2890-0467
.022" x .028"	W-Fit	893-69..	892-68..	01-32	890-0168	890-0268	890-0468
	Easy-Fit	1893-69..	1892-68..	05-36	1890-0168	1890-0268	1890-0468
	Dura-Fit	2893-69..	2892-68..	05-36	2890-0168	2890-0268	2890-0468
.018" x .025"	W-Fit	893-66..	892-65..	01-32	890-0165	890-0265	890-0465
	Easy-Fit	1893-66..	1892-65..	05-36	1890-0165	1890-0265	1890-0465
	Dura-Fit	2893-66..	2892-65..	05-36	2890-0165	2890-0265	2890-0465
.022" x .028"	W-Fit	893-67..	892-66..	01-32	890-0166	890-0266	890-0466
	Easy-Fit	1893-67..	1892-66..	05-36	1890-0166	1890-0266	1890-0466
	Dura-Fit	2893-67..	2892-66..	05-36	2890-0166	2890-0266	2890-0466





Sofern nicht anders vermerkt, liefern wir mit lingualen Setzlaschen.
If not otherwise requested, we supply with lingual seating eyelets.





Dreifach-Bukkalröhrchen zum Kleben Triple buccal tubes for direct bonding

CE 0297

OK / Maxillary	Zahn tooth	Torque	Angulation	distaler Offset distal offset		auf Pad/on pad	
						rechts/right	links/left
 convertible		-14°	0°	14°	.018" x .025"	741-0704	740-0704
					.022" x .028"	741-0702	740-0702

Zweifach-Bukkalröhrchen zum Kleben Double buccal tubes for direct bonding

OK / Maxillary	Zahn tooth	Torque	Angulation	distaler Offset distal offset		auf Pad/on pad	
						rechts/right	links/left
 convertible		-14°	0°	14°	.018" x .025"	741-0728	740-0728
					.022" x .028"	741-0726	740-0726

UK / Mandibular		Torque	Angulation	distaler Offset distal offset			
 convertible		-30°	0°	4°	.018" x .025"	741-1704	740-1704
					.022" x .028"	741-1702	740-1702
		0°	0°	0°	.018" x .025"	750-8410	750-8410

Einfach-Buccalröhrchen zum Kleben

Single buccal tubes for direct bonding

CE 0297

OK/ Maxillary	Zahn tooth	Torque	Angulation	distaler Offset distal offset		auf Pad/on pad	
						rechts/right	links/left
 convertible	6 6	-10°	0°	8°	.018" x .025"	743-0704	742-0704
					.022" x .028"	743-0702	742-0702
 convertible	6 6	0°	0°	0°	.018" x .025"	743-2704	742-2704
					.022" x .028"	743-2702	742-2702
 convertible	76 67	-10°	0°	7°	.018" x .025"	757-8312	757-8212
 convertible	7 7	-14°	0°	14°	.018" x .025"	741-0804	740-0804
					.022" x .028"	741-0802	740-0802
 convertible	7 7	-14°	0°	10°	.018" x .025"	728-0804	727-0804
					.022" x .028"	728-0802	727-0802
 convertible	7 7	-10°	0°	12°	.018" x .025"	774-0804	773-0804
					.022" x .028"	774-0802	773-0802
 convertible	7 7	-9°	0°	10°	.022" x .028"	748-8322	748-8222
 convertible	7 7	-10°	0°	6°	.018" x .025"	776-0804	775-0804

Einfach-Buccalröhrchen zum Kleben Single buccal tubes for direct bonding

CE 0297



UK / Mandibular	Zahn tooth	Torque	Angulation	distaler Offset distal offset		 auf Pad/on pad	
						rechts/right	links/left
 convertible		-22°	6°	5°	.018" x .025"	776-1704	775-1704
		0°	0°	0°	.018" x .025"	748-8311	748-8211
					.022" x .028"	748-8321	748-8221
 convertible		0°	0°	0°	.018" x .025"	742-2704	743-2704
					.022" x .028"	742-2702	743-2702
 convertible		-25°	0°	6°	.018" x .025"	743-1704	742-1704
					.022" x .028"	743-1702	742-1702
		-30°	0°	4°	.018" x .025"	741-1804	740-1804
					.022" x .028"	741-1802	740-1802
		-30°	0°	0°	.022" x .028"	748-8325	748-8225
		-27°	0°	12°	.018" x .025"	774-1804	773-1804
					.022" x .028"	774-1802	773-1802
		-27°	0°	6°	.018" x .025"	776-1804	775-1804
		-22°	0°	12°	.018" x .025"	758-8314	758-8214
		-10°	0°	0°	.018" x .028"	728-1804	727-1804
					.022" x .028"	728-1802	727-1802

Ni-Free* Products

W-Fit bands Roth System Titanium coated

CE 0297







OK/ Maxillary	Zahn tooth	Torque	Angulation	distaler Offset distal offset	Bändergröße band size			
					Einzelbänder single bands rechts/right	Einzelbänder single bands links/left		
 occlusal headgear tube	 6 6	-14°	0°	14°	.018" x .025"	B883-72	B882-71	01-32
					.022" x .028"	B883-88	B882-87	01-32





Buccal tubes for direct bonding Ni-Free



Pad sandgestrahlt
Sandblasted pad

OK/ Maxillary	Zahn tooth	Torque	Angulation	distaler Offset distal offset	auf Pad (10 Stück/10 pcs.)		
					rechts/right	links/left	
 convertible	 6 6	-14°	0°	14°	.018" x .025"	741M0704	740M0704
					.022" x .028"	741M0702	740M0702
	 7 7	-14°	0°	14°	.018" x .025"	741M0804	740M0804
					.022" x .028"	741M0802	740M0802



UK/ Mandibular	Zahn tooth	Torque	Angulation	distaler Offset distal offset			
					.018" x .025"	741M1704	740M1704
 convertible	 6 6	-30°	0°	4°	.022" x .028"	741M1702	740M1702
					.018" x .025"	741M1804	740M1804
	 7 7	-30°	0°	4°	.022" x .028"	741M1802	740M1802

*Nickel free

Aufschweißdienst Prewelding Service

Auf FORESTADENT[®]-Bänder werden alle in diesem Katalog aufgeführten Bukkalröhrchen und die nachfolgend angegebenen Brackets kostenlos aufgeschweißt:

- St. Edgewise N
- Andrews N
- St. Ricketts N
- Alexander S
- Roth N

Sonderschweißungen sind vom Umtausch ausgeschlossen.
Fremdfabrikate werden gegen Aufpreis ohne Garantieleistung aufgeschweißt.

On FORESTADENT[®] bands we are welding all attachments indicated in this catalogue as well as the following brackets:

- St. Edgewise N
- Andrews N
- St. Ricketts N
- Alexander S
- Roth N

Special weldings cannot be exchanged or credited. Items, which are not our own manufacture, are welded against a surcharge, however, without any warranty.

OK-Prämolaren-Bänder Maxillary premolar bands

CE 0297

Bei Bestellung von Einzelbändern bitte die Bestellnummer mit der gewünschten **Bandgröße** ergänzen.
When ordering single bands please add required **band size** to the given order numbers.

OK/ Maxillary

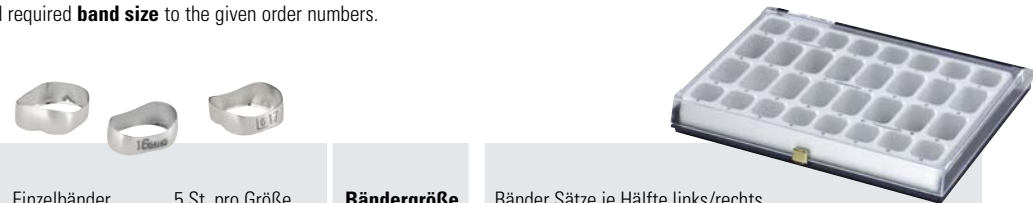



Zahn tooth	Band-Typ band-type	Einzelbänder single bands		Bändergröße band size	Bänder Sätze je Hälfte links/rechts band kits half left/half right		
		rechts/right	links/left		100 St./pieces	200 St./pieces	400 St./pieces
 54 45	–	860-00..		01...32	860-0100	860-0200	860-0400

3

UK-Prämolaren-Bänder Mandibular premolar bands

UK/ Mandibular



Zahn tooth	Band-Typ band-type	Einzelbänder single bands		Bändergröße band size	Bänder Sätze je Hälfte links/rechts band kits half left/half right		
		rechts/right	links/left		100 St./pieces	200 St./pieces	400 St./pieces
 5 5	–	875-00..		05...32	875-0100	875-0200	875-0400
 4 4	–	870-00..		01...32	870-0100	870-0200	870-0400



Sofern nicht anders vermerkt, liefern wir mit lingualen Setzlaschen.
If not otherwise requested, we supply with lingual seating eyelets.

Lingualschlösser

Lingual cleats

CE 0297

Order No.		Offset	Inhalt contents	Beschreibung description
links/left	rechts/right			
760-0084	760-0085	0°	10	<p>Lingualschloß mit Stopkerbung, offen, für Palatal Bar und Quad Helix</p> <p>Lingual cleat with latching indent, open, for Palatal Bar and Quad Helix</p>
760-0086	760-0087	0°	10	
760-0081		0°	10	
760-0088	760-0089	6°	10	